

Packaging Plástico Cosmético

Embalagens Plásticas para a Indústria Cosmética



GERRESHEIMER

Nuestra gama de productos de packaging plástico cosmético

Nossa gama de produtos de embalagens plásticas para cosméticos

Soluciones plásticas a medida – Soluções personalizadas em plástico

www.gerresheimer.com



...en diferentes opciones standard

...em diferentes padronizações



...o desarrollos exclusivos e innovadores

...ou desenvolvidos individualmente e de modo inovador



...especializados en packaging plástico

...especializados em embalagens plásticas

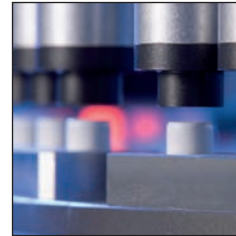

...y con tecnologías de vanguardia

...e com a mais alta tecnologia



...con calidad asegurada

...com qualidade de A a Z



...y con eficientes relaciones con nuestros clientes

...e em sistemas de parcerias completas e eficientes

Nos especializamos en packaging plástico farmacéutico y cosmético para sólidos y líquidos tanto standard como exclusivos. Los productos de las marcas líderes Duma, Allplas y EDP representan una amplia e innovadora gama de nuestros productos. Mediante nuevas ideas y nuestra experiencia ofrecemos soluciones de packaging inteligentes para un uso seguro y amistoso. Por todo esto nos consideramos un socio innovador en la industria farmacéutica y cosmética mundial.

Somos especializados em embalagens plásticas para as indústrias farmacêutica e cosmética nos padrões standard e exclusivos, tanto para sólidos, quanto para líquidos. Produtos de marcas Duma, Allplas e EDP integram o amplo e inovador leque de produtos por nós produzidos. Idéias novadoras somadas à nossa experiência são o resultado de soluções para embalagens inteligentes concebidas para uso seguro e divertido, razões pelas quais nos consideramos parceiros inovadores das indústrias farmacêutica e cosmética no mundo.



Nuestra gama de productos de packaging plástico cosmético

Nossa gama de produtos de embalagens plásticas para cosméticos

El conocimiento y la experiencia en los sectores de packaging plástico farmacéutico y cosmético son una parte importante de la división Plastic Systems de Gerresheimer. Ofrecemos una amplia variedad de soluciones innovadoras y de alta calidad en packaging para sólidos y líquidos.

Una amplia e innovadora gama de productos

Nuestra gama de productos se encuentra altamente diversificada. Se adapta a la multiplicidad de requerimientos de la industria cosmética en cuanto a formas y tamaños. A través de nuestros desarrollos contribuimos a la innovación en formatos y materiales.

Producción y calidad

Nuestra producción utiliza tecnología de vanguardia y aplica los más rigurosos standards de calidad e higiene. Esto incluye todas las tecnologías de producción, desde inyección, inyección-soplado e inyección soplado biorientado hasta procesos de extrusión-soplado y coextrusión-soplado. Nuestras unidades productivas trabajan según las Buenas Prácticas de Manufactura (GMP) y contamos con plantas certificadas bajo la norma ISO 9001.

Tecnología y know-how: Bases para desarrollar productos orientados al mercado

La continua dedicación al desarrollo de nuevos productos y a la tecnología son la clave de los diseños del packaging de Gerresheimer. Gracias a ello, ofrecemos al mercado cosmético los últimos desarrollos en sistemas de packaging. Conocemos, entendemos y fortalecemos los negocios de nuestros clientes.

Como proveedores de soluciones completas orientados a la innovación, documentación y tecnología, buscamos convertirnos en el socio global preferido en packaging plástico cosmético y aportar diferenciación a los productos de nuestros clientes.



O conhecimento e a experiência nos setores de embalagens plásticas para uso farmacêutico e cosmético fazem parte da importante Divisão de Sistemas de Plástico do Grupo Gerresheimer que oferecem uma ampla variedade de soluções inovadoras e de altíssima qualidade para embalagens de produtos sólidos e líquidos.

Um leque amplo, profundo e inovador

Nossa gama de produtos é altamente diversificada e adaptada à multiplicidade de quesitos exigidos pela indústria cosmética, quer em relação à formas, quer em relação à medidas. O ritmo do nosso desenvolvimento inova os formatos e os materiais.

Produção e qualidade

Nossas operações são realizadas sempre com as tecnologias mais avançadas e a elas são aplicados os padrões mais rigorosos de higiene e qualidade. Isto cobre todas as tecnologias de produção desde os processos de injection moulding, injection-blow moulding e injection stretch blow moulding até os de blow moulding, extrusion e sopro coextrusado. Todas as unidades produtivas aplicam as regras das Boas Práticas de Fabricação (GMP) e possuímos plantas com certificado ISO 9001.

Tecnologia e know-how: a base para o desenvolvimento de produtos orientado pelo mercado

A chave da Gerresheimer para estabelecer seus padrões para o design de seus produtos é a contínua dedicação nos campos da tecnologia de pesquisa e desenvolvimento. Com esta base nós somos capazes de servir ao mercado cosmético com as últimas novidades em desenvolvimento de sistemas de embalagens. Nós conhecemos, entendemos e reforçamos o negócio de nossos clientes.

Como fornecedor de soluções completas para nossos clientes focados em inovação, documentação e tecnologia, nossa meta é ser o parceiro global preferido em embalagens plásticas para a indústria cosmética com o objetivo de criar clara preferência por nossos produtos.

Packaging Plástico Cosmético – Embalagens Plásticas para a Indústria Cosmética

	Botellas en PET	Frascos PET
	Botellas en Soft Touch	Frascos Soft Touch
	Roll-on Botellas en HDPE	Roll-on Frascos HDPE

1

2

3

Packaging Plástico Cosmético – Embalagens Plásticas para a Indústria Cosmética

Botellas en PET – Frascos PET



Línea Omega

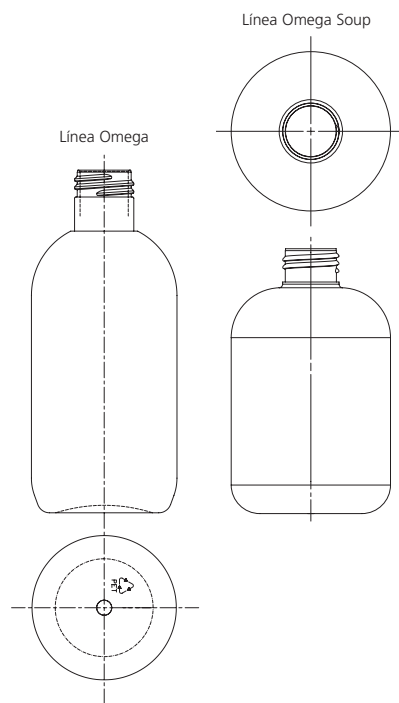

Omega60	20/410	PET	12.5	424	60.0	66.0	37.8	81.9	20/410
Omega100	20/410	PET	17	374	100.0	110.0	41.5	108.0	20/410
Omega100	20/415	PET	17	479	100.0	113.0	41.5	113.0	20/415
Omega100	DIN20	PET	14	486	100.0	113.0	41.5	107.5	DIN20
Omega125	20/410	PET	16	355	125.0	134.0	46.1	107.0	20/410
Omega150	24/410	PET	16.5	446	150.0	154.0	52.0	101.0	24/410
Omega200	24/410	PET	22	428	200.0	210.0	55.0	115.0	24/410
Omega250	24/410	PET	22.5	603	250.0	263.0	58.0	128.0	24/410
Omega250	24/415	PET	22.5	604	250.0	267.0	58.0	135.7	24/415
Omega350	24/410	PET	27	432	350.0	360.0	64.1	141.1	24/410
Omega350	24/415	PET		430	350.0	363.0	64.1	149.0	24/415
Omega500	24/415	PET	36	911	500.0	527.0	70.0	178.0	24/415
OmegaSoap300	24/410	PET		433	300.0	310.0	68.3	114.8	24/410

Fuera de escala – Desenhos fora de escala

- Tapas flip-top recta, flip-top hongo, disk-top y ciegas GCMi 20/410, 20/415, 24/410 y 24/415
- Bombas cremeras y spray
- Botellas disponibles en cristal, consultar por colores

- Diversas tampas flip-top, disk-top e GCMi 20/410, 20/415, 24/410 e 24/415
- Bombas para cremes e sprays
- Frascos disponíveis em cor transparente (consultar outras cores)

11/09 PPC 1.1

Packaging Plástico Cosmético – Embalagens Plásticas para a Indústria Cosmética

Botellas en PET – Frascos PET



Línea Hydra

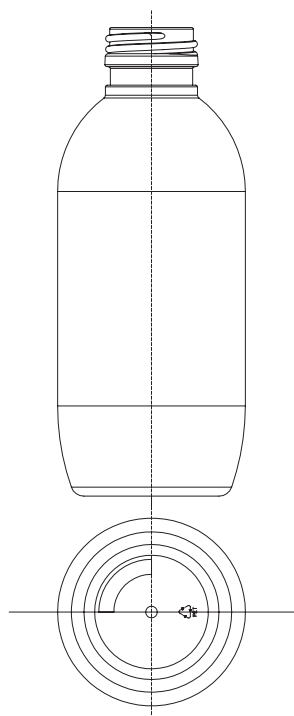

Hydra250 RP28 PET 22.4	376	250.0	262.0	56.2	140.3	RP28
Hydra350 RP28 PET 27	377	350.0	355.0	62.5	154.8	RP28

- Tapa en polipropileno con precinto y disco
- Botellas disponibles en cristal, consultar por colores
- Tampa em polipropileno com lacre e disco
- Frascos disponíveis em cor transparente (consultar outras cores)

Packaging Plástico Cosmético – Embalagens Plásticas para a Indústria Cosmética

Botellas en PET – Frascos PET



Línea RO

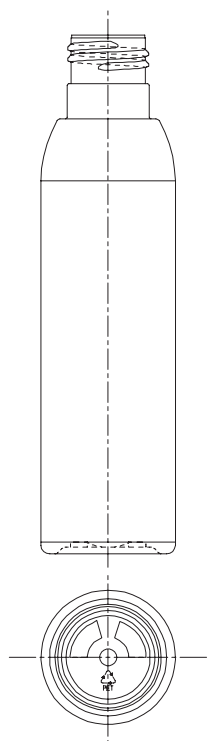

Ro75 20/410 PET 12.5	481	75.0	81.5	34.7	112.0	20/410
Ro75 20/415 PET 12.5	480	75.0	83.0	34.7	116.7	20/415
Ro100 20/410 PET 18	464	100.0	108.0	38.0	123.5	20/410
Ro125 24/410 PET 16.5	518	125.0	138.0	39.0	142.7	24/410
Ro125 24/415 PET 16.5	519	125.0	141.0	39.0	150.6	24/415
Ro200 24/410 PET 23	916	200.0	215.0	45.6	161.5	24/410
Ro200 24/415 PET 23	351	200.0	218.0	45.6	169.4	24/415
Ro300 24/410 PET 23	369	300.0	305.0	52.0	174.0	24/410
Ro300 24/415 PET 23	926	300.0	312.0	52.0	182.3	24/415

- Tapas flip-top recta, flip-top hongo, disk-top y ciegas GCM1 20/410, 20/415, 24/410 y 24/415
- Bombas cremeras y spray
- Botellas disponibles en cristal, consultar por colores

- Diversas tampas flip-top, disk-top e GCM1 20/410, 20/415, 24/410 e 24/415
- Bombas para cremes e sprays
- Frascos disponíveis em cor transparente (consultar outras cores)

Packaging Plástico Cosmético – Embalagens Plásticas para a Indústria Cosmética

Botellas en PET – Frascos PET



Línea Beta

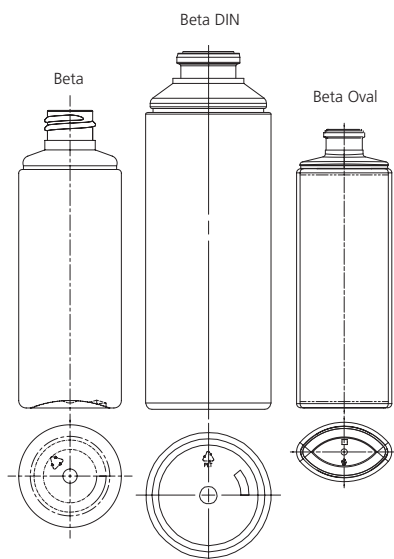

Beta40 DIN15 PET 11	434	40.0	45.0	30.0	85.7	DIN15
Beta75 DIN20 PET 14.3	495	75.0	93.0	38.1	105.0	DIN20
Beta75 DIN20 PET 18	408	75.0	93.0	38.1	105.0	DIN20
Beta100 DIN20 PET 18	940	100.0	125.0	41.3	117.5	DIN20
Beta100 20/410 PET 17.5	476	100.0	125.0	41.3	117.5	20/410
Beta100 20/415 PET	477	100.0	125.0	41.3	122.5	20/415
Beta125 DIN20 PET 18	950	125.0	150.0	41.3	135.7	DIN20
BetaOval75 DIN20 PET 14	467	75.0	84.0	46.0 x 28.7	109.5	DIN20

- Tapas flip-top recta, disk-top y ciegas GCM I 20/410 y 20/415
- Bombas cremeras y spray
- Capuchones para frascos ovales y cilíndricos
- Botellas disponibles en cristal, consultar por colores
- Diversas tapas flip-top, disk-top e GCM I 20/410, 20/415
- Bombas para cremes e sprays
- Tapas para frascos ovais e cilíndricos
- Frascos disponíveis em cor transparente (consultar outras cores)

Packaging Plástico Cosmético – Embalagens Plásticas para a Indústria Cosmética

Botellas en PET – Frascos PET



Línea Tube – Línea Tricor

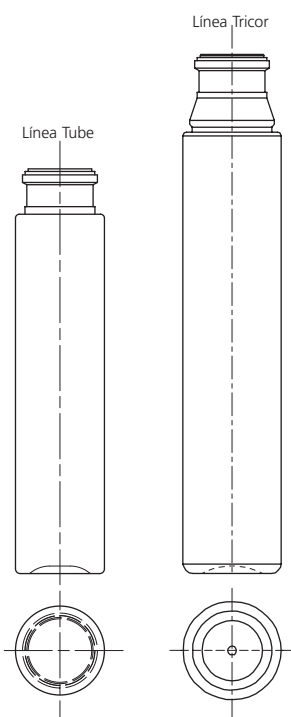

Mini Tube10 DIN15 PET 7	699	10.0	11.0	18.5	64.7	DIN15
Tube30 DIN20 PET 14	458	30.0	33.0	23.5	107.0	DIN20
Tube30 20/410 PET 12.5	404	30.0	33.0	23.5	108.5	20/410
Tricor50 DIN20 PET 18	496	50.0	55.0	26.5	137.5	DIN20

- Tapas flip-top rectas, disk-top y ciegas
- Bombas cremeras y spray
- Capuchones para frascos cilíndricos
- Botellas disponibles en cristal, consultar por colores

- Diversas tampas flip-top, disk-top
- Bombas para cremes e sprays
- Tampas para frascos cilíndricos
- Frascos disponíveis em cor transparente (consultar outras cores)

Packaging Plástico Cosmético – Embalagens Plásticas para a Indústria Cosmética

Botellas en PET – Frascos PET



Línea Heaven – Línea Maxi

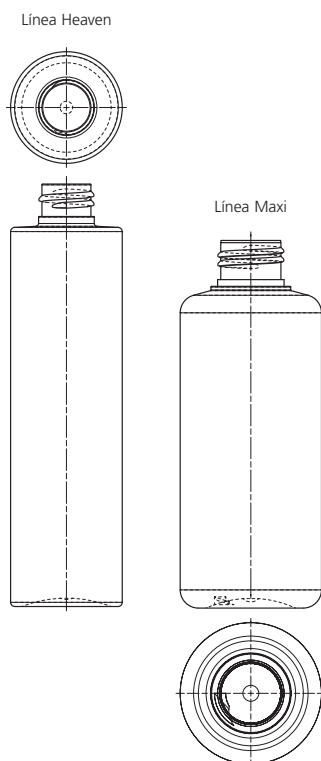

Heaven120 20/410 PET 17	357	120.0	139.0	43.1	120.1	20/410
Heaven150 20/410 PET 17	425	150.0	160.0	39.9	151.0	20/410
Heaven200 24/410 PET 27.8	423	200.0	225.0	43.8	176.7	24/410
Maxi200 24/410 PET 22.5	492	200.0	211.0	50.5	131.4	24/410

- Tapas flip-top recta, flip-top hongo, disk-top y ciegas GCMI 20/410 y 24/410
- Bombas cremeras y spray
- Capuchones para frascos cilíndricos
- Botellas disponibles en cristal, consultar por colores

- Diversas tampas flip-top, disk-top e GCMI 20/410
- Bombas para cremes e sprays
- Tampas para frascos cilíndricos
- Frascos disponíveis em cor transparente (consultar outras cores)

Packaging Plástico Cosmético – Embalagens Plásticas para a Indústria Cosmética

Botellas en PET – Frascos PET



Línea Oval

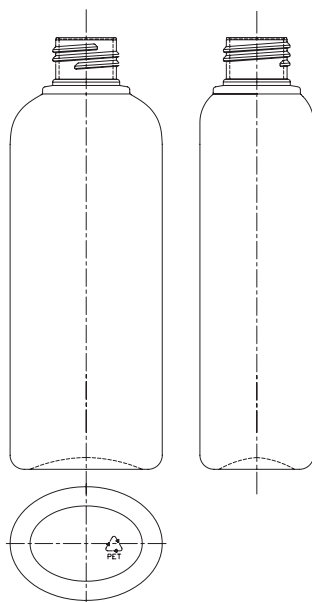

Oval60	20/410	PET	12.5	453	60.0	65.0	41.6 x 25.4	97.6	20/410
Oval140	24/410	PET	16.5	387	140.0	157.0	55.0 x 33.0	136.0	24/410
Oval140	24/410	PET	22	902	140.0	156.0	55.0 x 33.0	136.4	24/410
Oval140	24/415	PET	16.5	483	140.0	161.0	55.0 x 33.0	144.3	24/415
Oval140	24/415	PET	22	914	140.0	161.0	55.0 x 33.0	144.3	24/415
Oval200	24/410	PET	23	388	200.0	214.0	53.9 x 40.3	151.7	24/410
Oval200	24/415	PET	23	921	200.0	214.0	53.9 x 40.3	160.3	24/415
Oval280	24/410	PET	23	394	280.0	290.0	58.5 x 45.6	167.3	24/410
Oval280	24/415	PET	23	395	280.0	293.0	58.5 x 45.6	168.4	24/415
Oval350	24/415	PET	36	917	350.0	385.0	64.5 x 49.9	193.7	24/415

- Tapas flip-top recta, flip-top hongo, disk-top y ciegas GCMi 20/410, 24/410 y 24/415
- Bombas cremeras y spray
- Botellas disponibles en cristal, consultar por colores

- Diversas tampas flip-top, disk-top e GCMi 20/410, 24/410 e 24/415
- Bombas para cremes e sprays
- Frascos disponíveis em cor transparente (consultar outras cores)

Packaging Plástico Cosmético – Embalagens Plásticas para a Indústria Cosmética

Botellas en PET – Frascos PET



Línea Delta

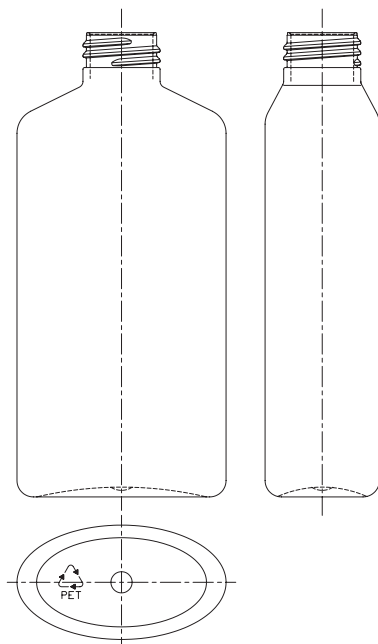

Delta125 24/410 PET 16.5	330	125.0	132.0	57.0 x 30.0	123.15	24/410
Delta125 24/410 PET 22.5	473	125.0	129.0	57.0 x 30.0	123.15	24/410
Delta125 24/415 PET 16.5	331	125.0	134.0	57.0 x 30.0	131.3	24/415
Delta125 24/415 PET 22.5	474	125.0	130.0	57.0 x 30.0	131.3	24/415
Delta200 24/410 PET 22.5	305	195.0	200.0	64.0 x 35.0	141.3	24/410
Delta200 24/415 PET 22.5	306	200.0	211.0	64.0 x 35.0	150.3	24/415

- Tapas flip-top recta, flip-top hongo, disk-top y ciegas GCMI, 24/410 y 24/415
- Bombas cremeras y spray
- Botellas disponibles en cristal, consultar por colores

- Diversas tampas flip-top, disk-top e 24/410 e 24/415
- Bombas para cremes e sprays
- Frascos disponíveis em cor transparente (consultar outras cores)

Packaging Plástico Cosmético – Embalagens Plásticas para a Indústria Cosmética

Botellas en PET – Frascos PET



Línea Tau

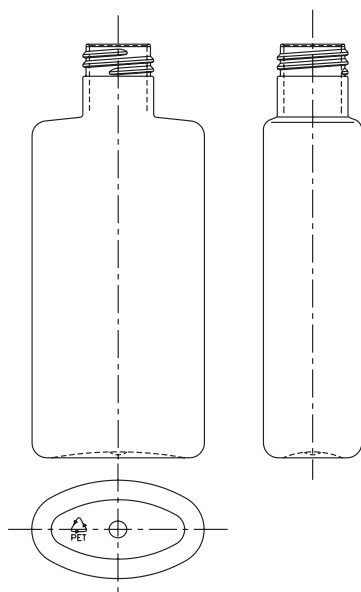

Tau150 24/410 PET 22.5	690	150.0	157.0	57.5 x 32.8	130.1	24/410
Tau150 24/410 PET 16.5	928	150.0	160.0	57.5 x 32.8	130.1	24/410
Tau150 24/415 PET 23	695	150.0	160.0	57.5 x 32.8	138.0	24/415
Tau150 24/415 PET 16.5	927	150.0	165.0	57.5 x 32.8	138.0	24/415

- Tapas flip-top recta, flip-top hongo, disk-top y ciegas GCM I 24/410 y 24/415
- Bombas cremeras y spray
- Botellas disponibles en cristal, consultar por colores

- Diversas tampas flip-top, disk-top e GCM I 24/410 e 24/415
- Bombas para cremes e sprays
- Frascos disponíveis em cor transparente (consultar outras cores)

Packaging Plástico Cosmético – Embalagens Plásticas para a Indústria Cosmética

Botellas en PET – Frascos PET



Línea Zoe – Línea Body Touch

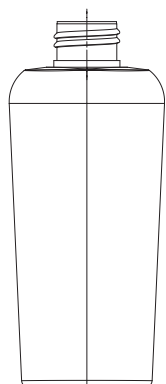
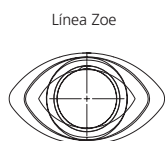

Línea Body Touch

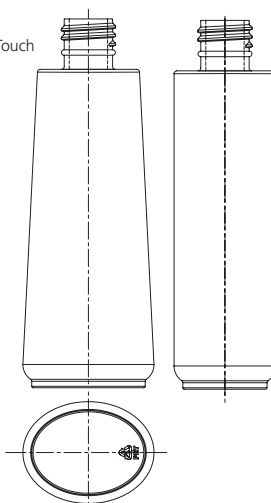

Zoe125 24/410 PET 16	499	125.0	134.0	55.8 x 32.9	131.4	24/410
Zoe125 24/415 PET 16	498	125.0	134.0	55.8 x 32.9	139.3	24/415
BodyTouch125 24/410 PET 17	454	125.0	132.0	47.5 x 37.0	129.6	24/410
BodyTouch125 24/415 PET 17.5	457	125.0	133.5	47.5 x 37.0	133.8	24/415
BodyTouch200 24/410 PET 23	494	200.0	218.0	57.3 x 44.8	147.9	24/410

- Tapas flip-top recta, flip-top hongo, disk-top y ciegas GCMi 24/410 y 24/415
- Bombas cremeras y spray
- Botellas disponibles en cristal, consultar por colores

- Diversas tapas flip-top, disk-top e 24/410 e 24/415
- Bombas para cremes e sprays
- Frascos disponíveis em cor transparente (consultar outras cores)

Packaging Plástico Cosmético – Embalagens Plásticas para a Indústria Cosmética

Botellas en PET – Frascos PET



Línea Anouk – Línea Lambda

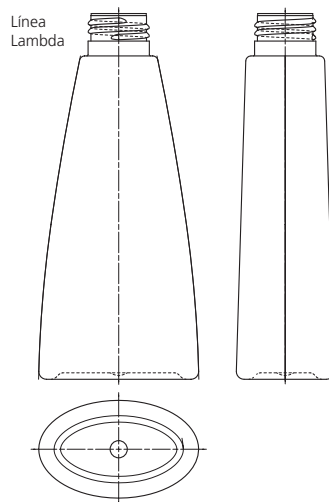
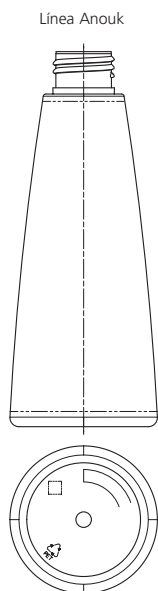

Anouk200 24/410 PET 22.5	470	200.0	211.0	57.0	145.1	24/410
Anouk200 24/415 PET 22.5	471	200.0	212.0	57.0	153.0	24/415
Lambda150 24/410 PET 16.5	629	150.0	157.0	61.4 x 37.8	141.0	24/410
Lambda150 24/415 PET 16.5	437	150.0	157.0	61.4 x 37.8	148.8	24/415

- Tapas flip-top recta, flip-top hongo, disk-top y ciegas GCMi 24/410 y 24/415
- Bombas cremeras y spray
- Botellas disponibles en cristal, consultar por colores

- Diversas tampas flip-top, disk-top e GCMi 24/410 e 24/415
- Bombas para cremes e sprays
- Frascos disponíveis em cor transparente (consultar outras cores)

Packaging Plástico Cosmético – Embalagens Plásticas para a Indústria Cosmética

Botellas en PET – Frascos PET



Línea Pump – Línea Soft

Pump150 20/415 PET 17,5	1	150.0	168.0	55.0 x 34.0	138.3	20/415
Soft250 24/415 PET 22,5	887	250.0	273.0	62.0 x 41.2	164.0	24/415

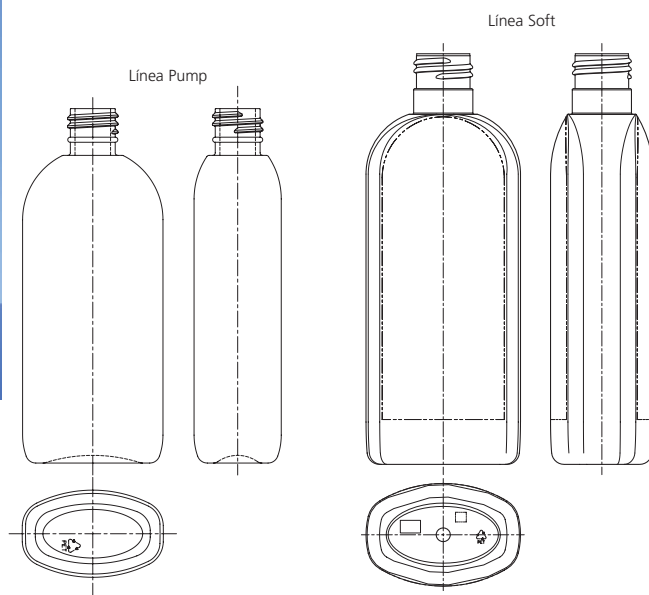

- Tapas flip-top recta, flip-top hongo, disk-top y ciegas GCMi 20/415 y 24/415
- Bombas cremeras y spray
- Botellas disponibles en cristal, consultar por colores

- Diversas tampas flip-top, disk-top e GCMi 24/410 e 24/415
- Bombas para cremes e sprays
- Frascos disponíveis em cor transparente (consultar outras cores)

Packaging Plástico Cosmético – Embalagens Plásticas para a Indústria Cosmética

Botellas en PET – Frascos PET



Línea Mini Kappa

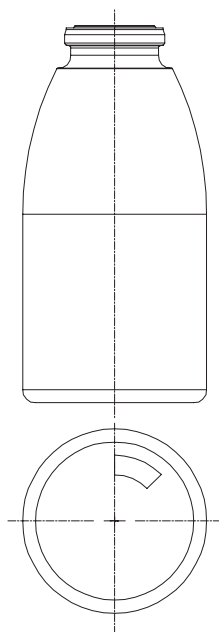

Mini Kappa15 DIN15 PET 7	463	15.0	20.5	26.2	59.3	DIN15
Mini Kappa25 DIN15 PET 11	462	25.0	35.5	27.25	85.0	DIN15

- Bombas cremeras y spray
- Botellas disponibles en cristal, consultar por colores

- Bombas para cremes e sprays
- Frascos disponíveis em cor transparente (consultar outras cores)

Packaging Plástico Cosmético – Embalagens Plásticas para a Indústria Cosmética

Botellas en PET – Frascos PET



Línea Cuadrada



Cuadrado100 RP28 PET 17.2	984	100.0	115.0	35.0 x 35.0	121.0	RP28
Cuadrado200 RP28 PET 22.5	427	200.0	212.0	50.2 x 43.0	137.6	RP28
Cuadrado200 RP28 PET 27	439	200.0	212.0	50.2 x 43.0	137.6	RP28
Cuadrado250 RP28 PET 22.5	919	250.0	266.0	54.0 x 54.0	137.6	RP28

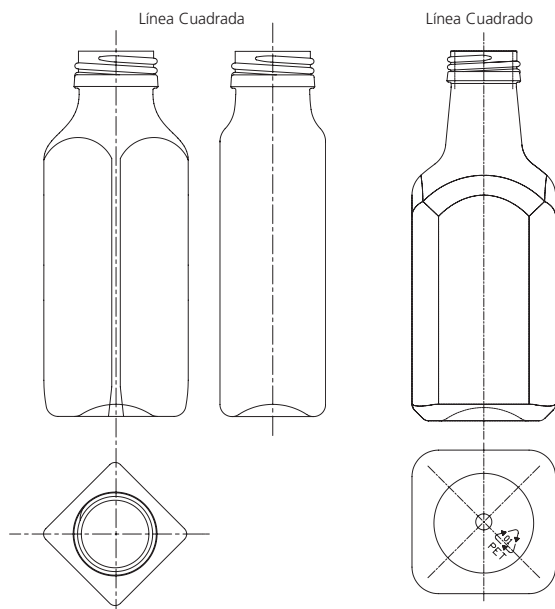

- Tapa en polipropileno con precinto y disco
- Botellas disponibles en cristal, consultar por colores

- Tampa em polipropileno com lacre e disco
- Frascos disponíveis em cor transparente (consultar outras cores)

Packaging Plástico Cosmético – Embalagens Plásticas para a Indústria Cosmética

Botellas en PET – Frascos PET



Línea Rectangular – Línea Square



Rectangular200 24/410 PET 23	461	200.0	225.0	54.3 x 39.7	135.9	24/410
Square150 24/410 PET 23	381	150.0	175.0	41.0 x 41.0	129.8	24/410
Square200 24/410 PET 23	430	200.0	222.0	41.6 x 41.6	158.7	24/410

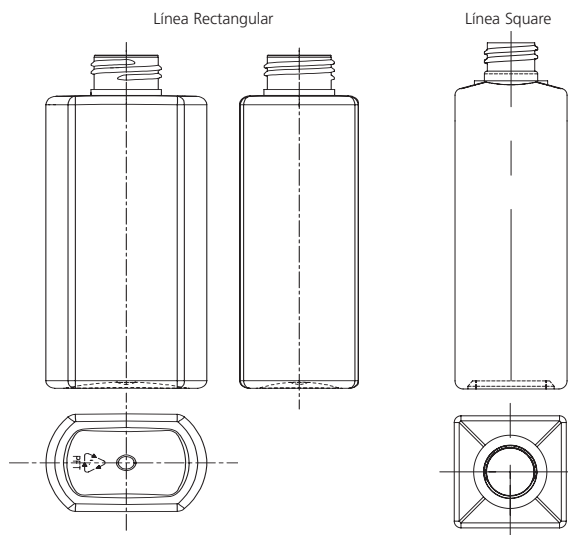

- Tapas flip-top recta, flip-top hongo, disk-top y ciegas GCM I 24/410
- Bombas cremeras y spray
- Botellas disponibles en cristal, consultar por colores

- Diversas tampas flip-top, disk-top e GCM I 24/410 e 24/415
- Bombas para cremes e sprays
- Frascos disponíveis em cor transparente (consultar outras cores)

Packaging Plástico Cosmético – Embalagens Plásticas para a Indústria Cosmética

Botellas en PET – Frascos PET



Línea Amphora

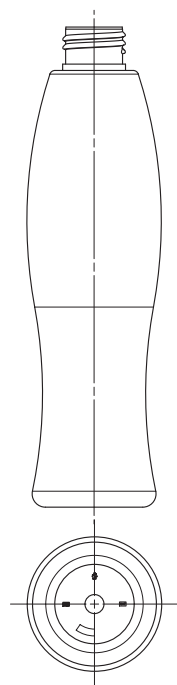

Amphora200 24/410 PET 23	709	200.0	212.0	46.8	180.5	24/410
--------------------------	-----	-------	-------	------	-------	--------

- Tapas flip-top recta, flip-top hongo, disk-top y ciegas GCMI 24/410
- Bombas cremeras y spray
- Botellas disponibles en cristal, consultar por colores

- Diversas tampas flip-top, disk-top e GCMI 24/410
- Bombas para cremes e sprays
- Frascos disponíveis em cor transparente (consultar outras cores)

Packaging Plástico Cosmético – Embalagens Plásticas para a Indústria Cosmética

Botellas en Soft Touch – Frascos Soft Touch



Línea Times

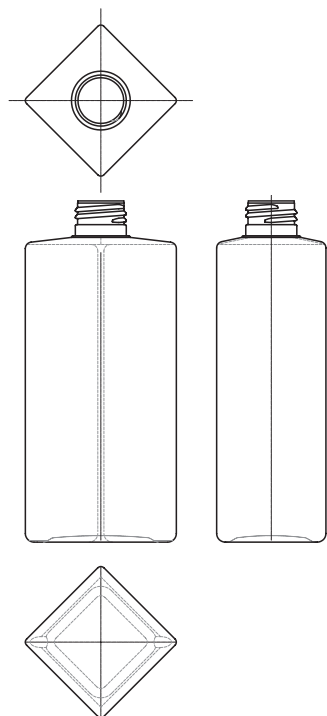

Times125 24/410 PP+ST 15	715	125.0	135.0	47.6 x 47.6	86.0	24/410
Times200 24/410 PP+ST 25	701	200.0	220.0	50.6 x 50.6	115.0	24/410
Times300 24/410 PP+ST 27	710	300.0	330.0	50.6 x 50.6	157.5	24/410

- Terminación Soft Touch
- Tapas flip-top recta, flip-top hongo, disk-top y ciegas GCMI 24/410
- Bombas cremeras y spray
- Botellas disponibles en natural, consultar colores

- Frasco Soft Touch (Coex)
- Diversas tampas flip-top, disk-top e GCMI 24/410
- Bombas para cremes e sprays
- Frascos disponíveis em natural (consultar outras cores)

Packaging Plástico Cosmético – Embalagens Plásticas para a Indústria Cosmética

Botellas en Soft Touch – Frascos Soft Touch



Línea Alpha

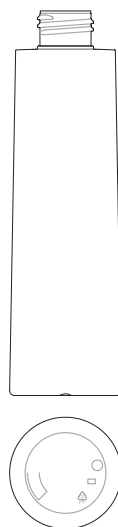

Alpha150 20/410 PP+ST 15	702	150	160	42	151,65	20/410
Alpha200 24/410 PP+ST 19	703	200	215	47	163,5	24/410

- Terminación Soft Touch
- Tapas flip-top recta, flip-top hongo, disk-top y ciegas GCMI 24/410 y 20/410
- Bombas cremeras y spray
- Botellas disponibles en natural, consultar colores

- Frasco Soft Touch (Coex)
- Diversas tampas flip-top, disk-top e GCMI 24/410 e 20/410
- Bombas para cremes e sprays
- Frascos disponíveis em natural (consultar outras cores)

Packaging Plástico Cosmético – Embalagens Plásticas para a Indústria Cosmética

Botellas en Soft Touch – Frascos Soft Touch



Línea Fiona

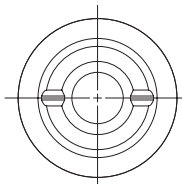
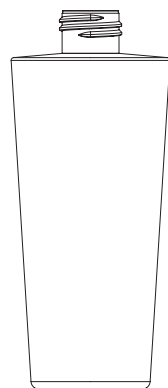
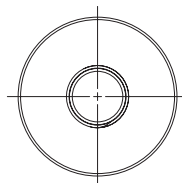

Fiona150 24/410 PP+ST 17	731	150	157	50	127	24/410
Fiona200 24/410 PP+ST 22.5	732	200	260	60	143	24/410

- Terminación Soft Touch
- Tapas flip-top recta, flip-top hongo, disk-top y ciegas GCMI 24/410 y 20/410.
- Bombas cremas y spray
- Botellas disponibles en natural, consultar colores

- Frascos Soft Touch (Coex)
- Diversas tampas: flip-top, disk-top e GCMI 24/410 e 20/410
- Bombas para cremes e sprays
- Frascos disponíveis em natural (consultar outras cores)

Packaging Plástico Cosmético – Embalagens Plásticas para a Indústria Cosmética

Botellas en Soft Touch – Frascos Soft Touch



Línea Frasnaga - Línea Component



Línea Frasnaga

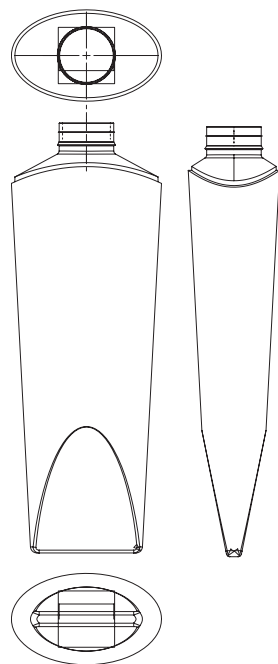

Línea Component

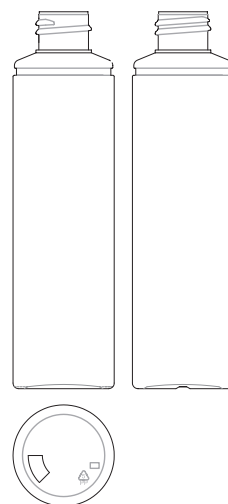

Frasnaga200 2035 PP+ST 24	716	200	215	64.5 x 39.3	187	2035
Component100 20/410 PP+ST 15	717	100	105	35.70	133	20/410

- Terminación Soft Touch
- Diversas opciones en tapas
- Bombas cremas y spray
- Botellas disponibles en natural, consultar colores

- Frascos Soft Touch (Coex)
- Diversas tapas
- Bombas para cremes e sprays
- Frascos disponíveis em natural (consultar outras cores)

Packaging Plástico Cosmético – Embalagens Plásticas para a Indústria Cosmética

Roll-on, Botellas en HDPE – Roll-on, Frascos HDPE

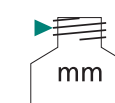
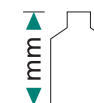
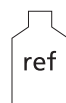

Linha Roll-on

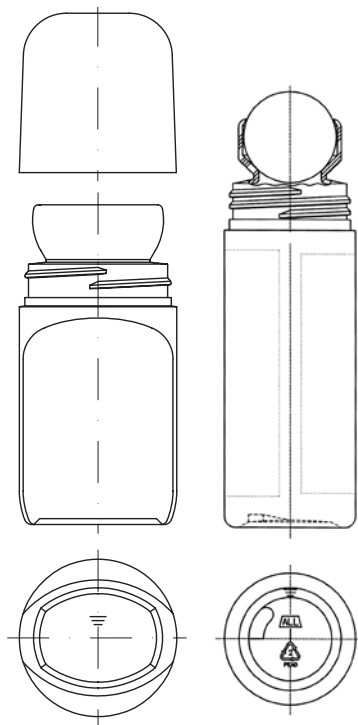

FR. ROLL-ON CIL.	70.0	87.7	36.0	113.3	35.0
FR. ROLL-ON BIG-BALL	90.0	108.0	34.5 x 47.5	96.5	45.0

Packaging Plástico Cosmético – Embalagens Plásticas para a Indústria Cosmética

Roll-on, Botellas en HDPE – Roll-on, Frascos HDPE



Línea Delta HDPE

Delta70 24/410 HDPE 13	407	70.0	79.0	55.5	78.4	24/410
Delta125 24/410 HDPE 19	580	125.0	135.0	57.0 x 31.3	124.2	24/410

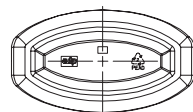
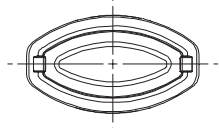
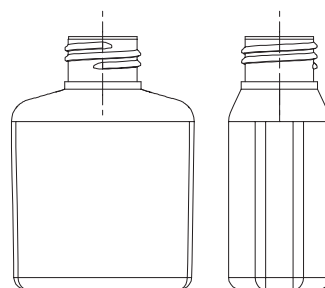
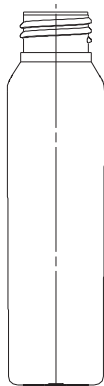
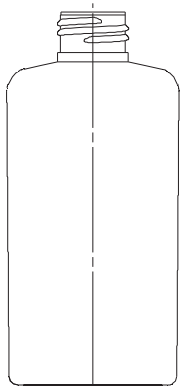
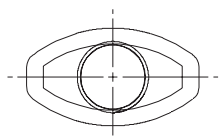

- Tapas flip-top recta, flip-top hongo, disk-top y ciegas GCMI 24/410
- Bombas cremeras y spray
- Botellas disponibles en natural y blanco

- Diversas tampas flip-top, disk-top e GCMI 24/410
- Bombas para cremes e sprays
- Frascos disponíveis em natural e branco leitoso

GERRESHEIMER

Gerresheimer Buenos Aires S.A.

Mercedes 2153 • Ciudad autónoma de Buenos Aires
CEP C1417AUA • Argentina
Tel. +54 11 4639 0771
Fax +54 11 4639 1041

Gerresheimer Plásticos Sao Paulo Ltda

Rodovia Raposo Tavares, km 25,6 • No. 25.599
CEP 06708-000 Cotia • Sao Paulo, Brazil
Tel. +55 11 4613 1000
Fax +55 11 4613 1007

Más información – Mais informação

E-mail info-plasticpackaging-SA@gerresheimer.com
Internet www.gerresheimer.com



Gerresheimer Buenos Aires S.A.
CEP C1417AUA • Argentina

Gerresheimer Plásticos Sao Paulo Ltda
CEP 06708-000 Cotia • Brazil

info-plasticpackaging-SA@gerresheimer.com · www.gerresheimer.com

GERRESHEIMER